

# MULTI-BAND AD-HOC COGNITIVE RADIO FOR REDUCING INTER SYSTEM INTERFERENCE

Takeo Fujii<sup>†</sup> Yukihiro Kamiya<sup>‡</sup> Yasuo Suzuki<sup>‡</sup>

<sup>†</sup>The University of Electro-Communications, 1-5-1, Chofugaoka, Chofu, Tokyo 182-8585, Japan

<sup>‡</sup>Tokyo University of Agriculture and Technology, 2-24-16, Nakacho, Koganei, Tokyo 184-8588, Japan

<sup>†</sup>E-mail: fujii@awcc.uec.ac.jp

## ABSTRACT

The cognitive radio is a secondary wireless communication system that can overlap the frequency band assigned to the primary system by recognizing the frequency status. Ad-hoc cognitive radio is considered for realizing the cognitive radio by using multi-hop communication networks without giving the large interference toward the primary system. We have proposed the STBC distributed ARQ system applied to the ad-hoc cognitive radio for realizing effective cognitive radio. This system can realize a multi-hop communication from the source terminal to the destination terminal without deciding the reliable route in advance. However, the affect of inter-system interference has not been evaluated yet. In this paper, in order to keep the interference level low at the receiver of the primary system, the permissible maximum transmit power of the cognitive terminals is analytically derived. Moreover, we propose a novel STBC distributed ARQ using multi-frequency band for improving the performance of the ad-hoc cognitive radio due to the small transmit power and the large interference from the primary system. Finally, we confirm the effectiveness of the proposed system by using computer simulations.

## I. INTRODUCTION

The cognitive radio has attracted researchers' attention in these days for realizing frequency sharing system at the frequency band assigned to the primary system [1][2]. In the cognitive radio, the secondary cognitive terminals transmit the signals on the frequency band assigned to the primary system by sensing the radio frequency band in order to avoid the interference toward the primary systems. However, it is difficult to recognize the status of the frequency band when the primary terminals only receive the signals. Therefore, we have proposed the concept of an ad-hoc cognitive radio in order to realize a wide area secondary communication system by using multi-hop networks [3]. Although the large transmit power on single-hop networks can support the large communication area, the interference toward the primary systems also becomes large if the primary system exists between the primary transmitter and the receiver. In the ad-hoc cognitive radio, the power of each terminal is suppressed to minimize the interference toward the primary system and the area of communication can expand by using the multi-hop networks. However, the routing protocol is complicated because the location and the active time of the primary system are not fixed. In order to improve the robustness of the ad-hoc cognitive radio without complicated routing protocol, we have proposed the STBC distributed ARQ method for ad-hoc networks [4]. In this system, the source terminal can transmit the data packet to the destination terminal without the knowledge of the position of each terminal. The error packet is retransmitted by ARQ scheme, and the surrounding relay nodes also simultaneously retransmit the packet triggered by the control packet from the source node. Therefore, if we apply this method to the ad-hoc cognitive radio, the reliable communication can be established even if the primary system exists. This is because the relay terminals can recognize the status of the frequency band by themselves and the communication links of

the cognitive radio are constructed with bypassing the interference of the primary system. So although the number of hops may increase, the packet is reached to the destination terminal with reliability. Moreover, the space time block code (STBC) can be applied in each terminal by regarding one terminal as one branch of STBC for achieving the network diversity gain [5].

In the previous paper, although we have proposed a concept of the ad-hoc cognitive radio using STBC distributed ARQ, the inter-system interference between the primary system and the cognitive radio has not been evaluated [3]. Therefore, in this paper, we evaluate the performance considering the inter-system interference between the ad-hoc cognitive radio and the primary system by using a numerical analysis and computer simulations. Here, we suggest the decision method of the permissible maximum transmit power of ad-hoc cognitive radio terminals not to affect to the communication of the primary system. Moreover, in order to avoid a large number of retransmission of the ad-hoc cognitive radio due to the interference from the primary system, we propose a multi-frequency band selection method by using the frequency table generated by the source terminal. By using the proposed method, the interference from and to the primary system can be reduced.

## II. AD-HOC COGNITIVE RADIO USING STBC DISTRIBUTED ARQ

In an ad-hoc cognitive radio, the interference toward the primary systems can be avoided by transmitting the signals with small power in each terminal, and the large communication area can be achieved by using multi-hop communication networks. Usually, ad-hoc networks require the routing protocol for deciding the route from the source terminal to the destination terminal. However, the location and the active time of the primary system are changed every second. Therefore, the pre-defined route is not effective for use in the cognitive radio system. Therefore, we apply the STBC distributed ARQ method for the protocol of the ad-hoc cognitive radio [3]. In the STBC distributed ARQ system, the packet is retransmitted from the surrounding terminals instead of the routing. By using this method, if the interfered area due to the existing primary system is appeared on the route from the source terminal to the destination terminal, the interfered area can be bypassed by recognizing the surrounding radio environment using carrier sense in each terminal. As a result, the communication can be established through other routes.

The image of the multi-hop network considered in this research is shown in Fig. 1. In order to improve the performance of the multi-hop communication system, the cooperative diversity method is applied by regarding one antenna of each terminal as one of the diversity branches [5]. STBC diversity is often used for the cooperative diversity system because the channel status information at the transmitter is not required.

Figure 2 shows the image of the transmission of the STBC distributed ARQ. The transmission procedure is shown below. (1) First, the source terminal transmits the data packet toward the destination terminal. The destination terminal and the sur-

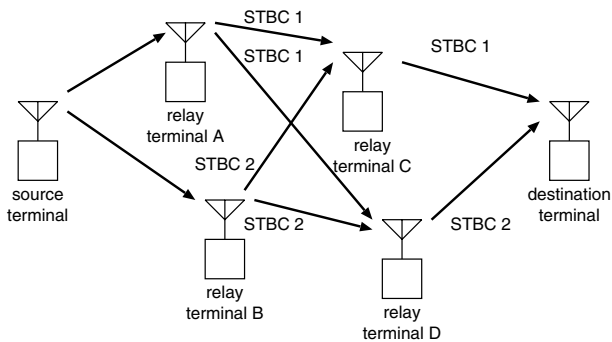

Figure 1: Multi-hop networks using cooperative diversity.

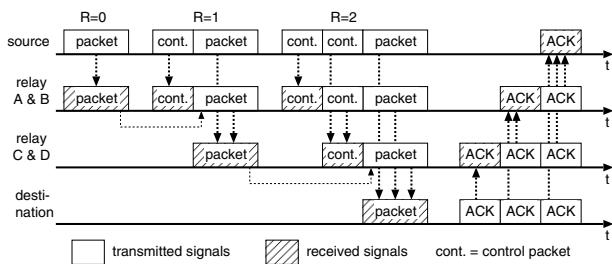

Figure 2: Packet transmission procedure for STBC distributed ARQ.

rounding terminals receive and detect the packet. If the destination of the packet is not for their terminals, the error of the decoded packet is checked and the packet without error is stored in the memory with the packet ID. (2) If the destination terminal can receive the packet without error, the destination terminal returns the acknowledgment packet (ACK) toward the source terminal. (3) If the source terminal receives ACK, the packet transmission is completed. However, if ACK packet is not received within the certain time, the control packet for retransmission is broadcasted  $R$  times.  $R$  is the number of retransmission of the same data packet from the source terminal. The control packet contains the source terminal ID, the destination terminal ID, the packet ID, and the pilot bits for synchronization. After the transmission of the control packets, the data packet is retransmitted. (4) At the relay terminal which already has the data packet for retransmission without error by using the previous frame, the control packets are transmitted  $R - n$  times adjusting the timing to the received control packet and after that the data packet is simultaneously transmitted from the source terminal and the surrounding relay terminals encoded by one of the branches of STBC, where  $n$  is the number of transmission of the control packets indicated in the present received control packet. (5) At the receiver of the destination terminal, the STBC decoding is operated and the data signals are recovered. If the destination terminal correctly receives the packet, the ACK packets are also simultaneously retransmitted to the source terminal as shown in Fig. 2. The number of transmission of ACK signals from the destination terminal is the same as the number of transmission of the data packet from the transmitter as  $R + 1$  times. Repeating (3) to (5) until the ACK packet is received at the source terminal or the number of retransmission is reached to the certain times.

As a result, the STBC distributed ARQ system can achieve the reliable communication from the source terminal to the des-

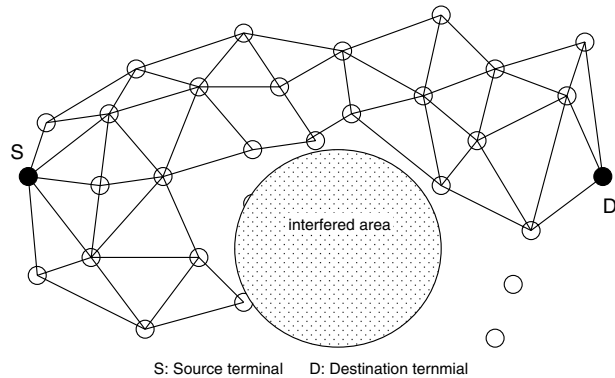

Figure 3: Communication link of STBC distributed ARQ with interference.

tinuation terminal without any routing protocol. If each terminal recognizes the active communication by carrier sense at the retransmission period, the terminal waits to retransmit the packet until the surrounding active communication is finished. After that, the retransmission is restarted. By using such operation, the multi-hop communication is established with avoiding the interfered area and we can realize ad-hoc cognitive radio system without giving large interference toward the primary system. The image of the communication links using STBC distributed ARQ with the interfered area caused by a primary system is shown in Fig. 3.

### III. TRANSMIT POWER DESIGN FOR AVOIDING INTERFERENCE TOWARD THE PRIMARY SYSTEM

In reference [3], we evaluate the performance of the ad-hoc cognitive radio in consideration of the interference from the primary system. However, the interference toward the primary system has never been evaluated. Therefore, in this paper, we derive the permissible maximum transmit power of the ad-hoc cognitive terminal with keeping the interference level at the primary receiver under the certain level. As one of the method to prevent the transmission when the primary system is active, a carrier sense technique is well known. If we apply the carrier sense technique to the terminals of the ad-hoc cognitive radio, the transmit power and the carrier sense threshold of each terminal decide the interference level at the primary receiver. Therefore, in this paper, we analyze the link budget of the communication of the cognitive radio and that of the primary system, in order to decide the permissible transmit power of the cognitive terminals without giving serious interference to the primary systems.

#### A. Link budget for the frequency sharing system

Here, we calculate the permissible maximum transmit power when the transmit power of the primary system is fixed. We assume the parameters of the primary system are already known at the cognitive terminal by using the assignment information of this frequency band. So that, we assume the transmit power and the maximum communication distance of the primary system is known in advance. The parameters of this analysis are shown as follows,

- Carrier sense level of cognitive terminal  $L_{cs}$
- Transmit power of the primary system  $P_{pr}$
- Maximum communication distance of the primary system  $d_i$

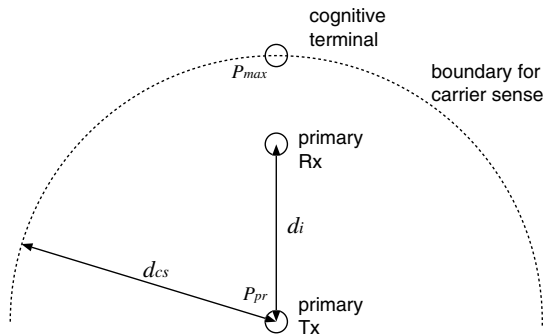

Figure 4: The position of relay terminal giving maximum interference.

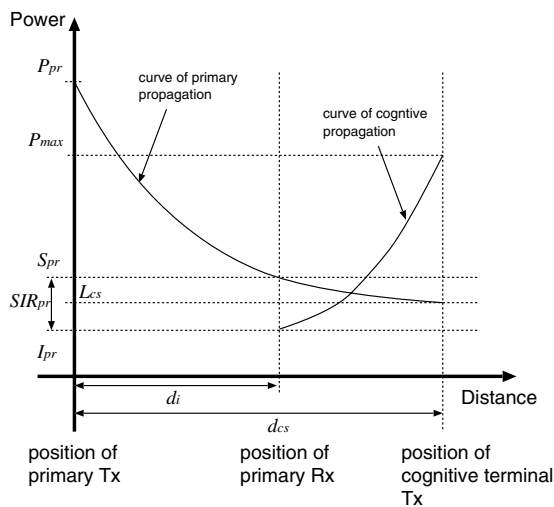

Figure 5: The relation of the distance and the power between the cognitive terminal and the primary system.

- Minimum required signal to interference plus noise ratio (SINR) at the receiver of the primary system  $SIR_{pr}$ .

We decide the permissible maximum transmit power  $P_{max}$  of cognitive terminals. Path loss attenuation factor is assumed to be 3 and  $d_0$  is the reference distance. The condition avoiding serious interference toward the primary receiver is decided by the interference from the cognitive terminal that is located on the edge of effective carrier sense area of the signals from the primary transmitter as shown in Fig. 4.

First, we decide the effective carrier sense area of the signals from the primary transmitter. In this paper, we only consider the path loss so that the fading and the shadowing are not considered in this calculation. The link budget deciding the effective carrier sense area in dB is shown by the following equation,

$$L_{cs} = P_{pr} - 20 \log_{10} \left\{ \frac{\lambda}{4\pi d_0} \right\} - 30 \log_{10} \left\{ \frac{\lambda}{4\pi d_{cs}} \right\}, \quad (1)$$

where the gain of each antenna is defined as 0 dBi,  $\lambda$  shows the wave length. From this equation we can derive the radius of the carrier sense area of the cognitive terminals as  $d_{cs}$ . The terminal located on the circumference of this circle is a candidate of the terminal giving the largest interference toward the primary receiver. The location of the terminal giving the largest

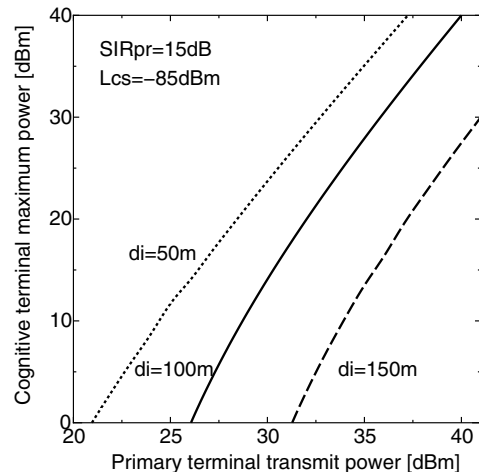

Figure 6: Maximum permissible transmit power against transmit power of the primary system.

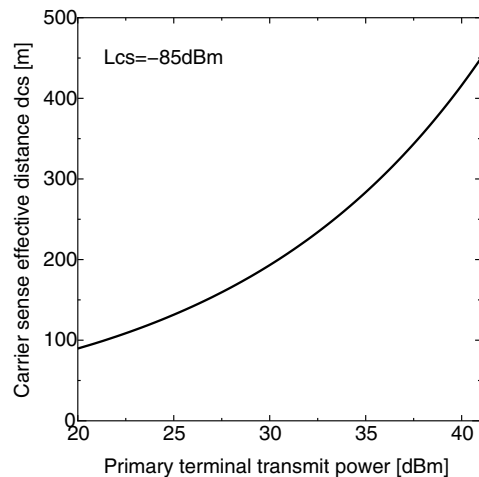

Figure 7: Effective carrier sense radius against transmit power of the primary system.

interference can be geometrically derived as the ‘‘cognitive terminal’’ shown in Fig. 4. By considering the interference from this terminal, the SIR at the primary receiver can be derived by,

$$SIR_{pr} = \left\{ P_{pr} - 20 \log_{10} \left\{ \frac{\lambda}{4\pi d_0} \right\} - 30 \log_{10} \left\{ \frac{\lambda}{4\pi d_i} \right\} \right\} - \left\{ P_{max} - 20 \log_{10} \left\{ \frac{\lambda}{4\pi d_0} \right\} - 30 \log_{10} \left\{ \frac{\lambda}{4\pi (d_{cs} - d_i)} \right\} \right\}. \quad (2)$$

By using above equation, we can decide the maximum transmit power of the cognitive terminal with keeping the minimum required SIR at the primary receiver. The relation of the distance and the power between the cognitive terminal and the primary system is summarized in Fig. 5.

### B. Numerical results

The numerical results of the maximum transmit power of the ad-hoc cognitive terminal against the transmit power of the primary transmitter are derived. Here, we set the parameters as  $d_i = 50m, 100m, 150m$ , the carrier sense level is  $L_{cs} = -85dBm$ ,  $SIR_{pr} = 15dB$ ,  $d_0 = 1m$ ,  $\lambda = 0.06m$  (5GHz). Fig-

Table 1: Frequency table for STBC distributed ARQ.

Number of repeat	Frequency channel
0	$f_2$
1	$f_3$
2	$f_1$
3	$f_0$

ure 6 shows the maximum transmit power of the cognitive terminal with keeping the SIR at the primary receiver over  $SIR_{pr}$ . It can be seen that the maximum transmit power depends on the communication distance of the primary system. Figure 7 shows the effective carrier sense radius against the transmit power of the primary system. The area of the effective carrier sense is decided by the transmit power of the primary transmitter and the carrier sense level of the cognitive terminal. From this figure, we can confirm that the permissible maximum transmit power increases if the transmit power of primary system increases. However, the effective carrier sense area becomes wider so that the number of interfered cognitive terminals also increases.

#### IV. MULTI-BAND AD-HOC COGNITIVE RADIO

In the previous section, we show the decision guideline of the transmit power of the cognitive relay terminals for the ad-hoc cognitive radio. The interference toward the primary system can be avoided by deriving the transmit power using this decision guideline and by applying the carrier sense operation in each terminal. However, the carrier sense decreases the number of terminals relaying the packet of the ad-hoc cognitive radio so that the packet success probability is degraded when the transmit power of the primary system becomes large. In particular, since the source terminal does not know the condition of the destination terminal in STBC distributed ARQ, the communication cannot be established if the destination terminal is interfered from the primary system. In this paper, in order to minimize the inter-system interference between the primary system and the cognitive radio with keeping flexibility of the STBC distributed ARQ, we propose a multi-band STBC distributed ARQ for ad-hoc cognitive radio. Some types of the multi-band can be considered as the plural frequency bands assigned to plural primary communication systems or the plural frequency channels assigned to one primary system. In this paper, we consider the plural frequency channels in one primary communication system so that the wave length used for deriving the path loss is the same among the frequency channels.

Many kinds of frequency channel assignment of each link can be considered for STBC distributed ARQ. In this paper, we use one of the frequency channels in each retransmission. In the proposed method, the source terminal generates the frequency table like shown in Table 1 and this table is transmitted through the packet. Each terminal selects the frequency channel according to this frequency table. First the source terminal senses the carrier and generates the list of the frequency channels excluding the interfered channel at the source terminal. In this paper, the frequency channels are randomly selected from the channel list and the frequency table is generated. On the other hand, the relay terminal transmits the control packet before data transmission. In the control packet, the number of retransmission of the packet is indicated for selecting the frequency channel in each terminal. Table 1 lists the frequency channels until the third retransmission so in the up to the fourth retransmission the frequency channel is selected from the first line of the table again.

The image of the packet transmission using multi-band is shown in Fig. 8. By using such multi-frequency channel, the performance of the ad-hoc cognitive radio can be improved be-

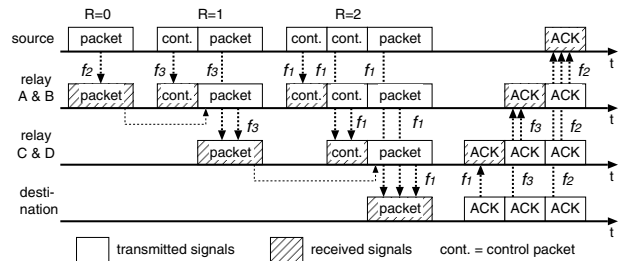

Figure 8: Packet transmission procedure using multi-frequency channel.

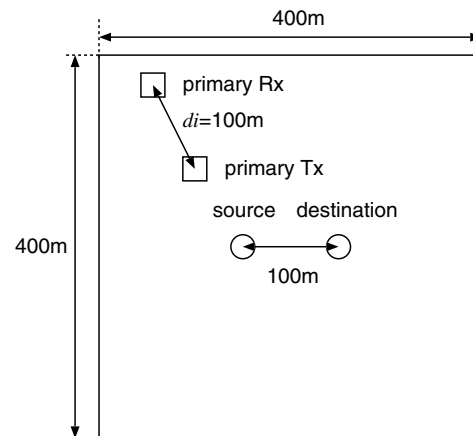

Figure 9: Simulation area.

cause the number of pending relay terminals due to the interference from primary systems decreases. Moreover, the interference toward the primary systems can be reduced because the number of transmitters using the same frequency band decreases.

#### V. SIMULATION RESULTS

In order to confirm the effectiveness of the proposed system, we perform the computer simulations. The model of the simulation is shown in Fig. 9. Here, we set the area  $400\text{m} \times 400\text{m}$ . The source terminal and the destination terminal of the ad-hoc cognitive radio are located with 100m apart each other on the center of the simulation area. 100 relay terminals of the cognitive radio and one pair of the primary system with 100m apart each other are considered in the simulation area. The location of the relay terminals and the primary receiver terminal are randomly located in the simulation area as shown in Fig. 9. The primary transmitter terminal is located 100m apart from the primary receiver terminal with random direction.

The simulation conditions are shown in Table 2. In this simulation, each relay terminal selects one of the STBC branch for deriving the diversity gain through multi-route. OFDM modulation is used for mitigating the influence of the timing offset among the relay terminals. The number of maximum retransmission is 10. The carrier sense is established by averaging the signals of 8 symbols before FFT. The number of frequency channels is 1, 2, and 4. The primary system uses one of the frequency channels of the frequency table. Therefore, if the number of frequency channel is 1, all transmission is established under the same channel of the primary system.

Figures 10 and 11 show the packet success probability (PSP) of the ad-hoc cognitive radio and SINR at the primary receiver,

Table 2: Simulation conditions.

Modulation method	QPSK
Number of subcarriers	128
FFT size	128
Length of guard interval	25 samples
FEC	Convolutional code (R=1/2, K=7)
Number of data symbols	60 symbols
Packet length	7674 bits
The number of relay nodes	100
The maximum number of re-transmission	$M = 10$
Path loss exponent	3
Reference distance	1 [m]
Carrier sense level	-85 [dBm]
Noise level	-95 [dBm]
Primary user transmit power	31.42 [dBm]
Primary user communication distance	100 [m]
Frequency	5 [GHz]
Channel model	5-path exponential Rayleigh fading
Path interval	4 samples

respectively. Here, we compare the performance of the proposed ad-hoc cognitive radio system under the interference from the primary system with 1, 2, and 4 frequency channels, and the performance of the proposed ad-hoc cognitive radio system without the primary systems with 1 frequency channel. It can be seen from the figures, when the number of frequency channel is 1, the PSP performance of the proposed system under the interference from the primary system degrades compared with the system without the primary system. This is because the relay terminals between the source terminal and the destination terminal are interfered from the primary system. If the transmit power of the ad-hoc terminal increases, the PSP performance of the ad-hoc cognitive radio is improved. However, the SIR performance of the primary system degrades. Moreover, the PSP performance is saturated even if the transmit power of the primary terminal increases. This is because the position of the transmitter of the primary system is random so that sometimes the source terminal is interfered from the primary signals. In this case, since the packet transmission is canceled at the source terminal, the packet is not reached to the destination terminal even if the transmit power increases. On the other hand, multi-band system can improve the PSP even if the interference occurs near the source terminal. In particular, when the number of frequency channel is 4, the performance of the ad-hoc cognitive radio under the primary system is better than that of the system without primary system with 1 frequency channel. This is because the frequency diversity gain by retransmission using the different frequency channel with different fading status can be achieved. Moreover, the interference toward the primary system also can be reduced by using the multi-band ad-hoc cognitive radio. From these results, the multi-band system is effective for use in the ad-hoc cognitive radio without large interference toward the primary system with keeping the communication area.

### VI. CONCLUSION

In this paper, we have proposed a multi-band ad-hoc cognitive radio for improving the performance of the cognitive radio and reducing the interference toward the primary system. Here, STBC distributed ARQ is applied for the protocol of the ad-hoc cognitive radio for generating the reliable communication without routing operation. In the proposed method, the frequency table is generated at the source terminal and the used frequency

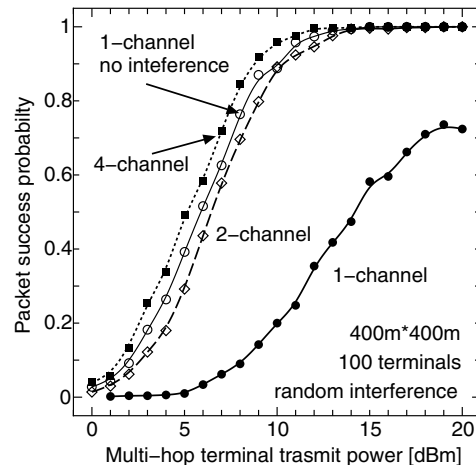

Figure 10: Packet success probability of the proposed multi-band system.

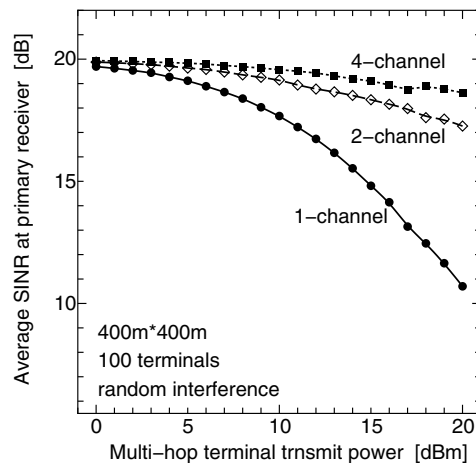

Figure 11: SIR performance of the primary receiver under the communication of ad-hoc cognitive radio.

channel is changed in each retransmission. By using the computer simulation, we can confirm that the proposed multi-band STBC distributed ARQ can achieve the reliable multi-hop communication without giving the large interference toward the primary system by limiting the transmit power of each relay terminals.

### REFERENCES

- [1] J. Mitra III, G. Q. Maguire JR., "Cognitive radio: making software radios more personal," IEEE Personal Commun., pp.13-18, Aug. 1999.
- [2] S. Haykin, "Cognitive radio: brain-empowered wireless communications," IEEE Journal Selected Areas Commun., vol.23, no.2, Feb. 2005.
- [3] T. Fujii and Y. Suzuki, "Ad-hoc cognitive radio -development to frequency sharing system by using multi-hop network-," Proc. IEEE DySPAN 2005, pp.589-592, Nov. 2005.
- [4] E. Kojima, T. Fujii, Y. Kamiya and Y. Suzuki, "Distributed ARQ using STBC for OFDM ad-hoc networks," Proc. IST Mobile and Wireless Communications Summit, June 2005.
- [5] J.N. Laneman, G. Wornell, "Distributed space-time-coded protocols for exploiting cooperative diversity in wireless networks," IEEE Trans. Inform. Theory, vol.49, no.10, pp.2415-2425, Oct. 2003.