1 Introduction to Ultra-Wideband Communications

I.1 INTRODUCTION

The recent rapid growth in technology and the successful commercial deployment of wireless communications are significantly affecting our daily lives. The transition from analog to digital cellular communications, the rise of third- and fourth-generation radio systems, and the replacement of wired connections with Wi-Fi and Bluetooth are enabling consumers to access a wide range of information from anywhere and at any time. As the consumer demand for higher capacity, faster service, and more secure wireless connections increases, new enhanced technologies have to find their place in the overcrowded and scarce radio frequency (RF) spectrum. This is because every radio technology allocates a specific part of the spectrum; for example, the signals for TVs, radios, cell phones, and so on are sent on different frequencies to avoid interference to each other. As a result, the constraints on the availability of the RF spectrum become more and more strict with the introduction of new radio services.

CHAPTER I INTRODUCTION TO ULTRA-WIDEBAND COMMUNICATIONS

Ultra-wideband (UWB) technology offers a promising solution to the RF spectrum drought by allowing new services to coexist with current radio systems with minimal or no interference. This coexistence brings the advantage of avoiding the expensive spectrum licensing fees that providers of all other radio services must pay.¹

This chapter provides a comprehensive overview of ultra-wideband communications, starting with its history and background. Next the discussion turns to the concepts behind UWB technology, as well as its advantages and challenges in wireless communications. The chapter also eliminates the common misconception about UWB and spread spectrum, and it examines the strengths and weaknesses of ultra-wideband compared to narrowband and wideband communications. Further, the single-band and multiband approaches that are two major UWB techniques under consideration for IEEE standardization are explained. Next we discuss the current Federal Communications Commission (FCC) regulations for UWB deployment in the United States and briefly address worldwide regulatory efforts. The chapter ends with a concise overview of UWB applications; we present a detailed discussion of present and future UWB applications and their potential markets in Chapter 5.

1.2 HISTORY AND BACKGROUND

Ultra-wideband communications is fundamentally different from all other communication techniques because it employs extremely narrow RF pulses to communicate between transmitters and receivers. Utilizing short-duration pulses as the building blocks for communications directly

1. The United Kingdom's spectrum auction for next-generation wireless applications generated \$35.4 billion in April 2000 [1].

I.2 HISTORY AND BACKGROUND

generates a very wide bandwidth and offers several advantages, such as large throughput, covertness, robustness to jamming, and coexistence with current radio services (see Section 1.4).

Ultra-wideband communications is not a new technology; in fact, it was first employed by Guglielmo Marconi in 1901 to transmit Morse code sequences across the Atlantic Ocean using spark gap radio transmitters. However, the benefit of a large bandwidth and the capability of implementing multiuser systems provided by electromagnetic pulses were never considered at that time.

Approximately fifty years after Marconi, modern pulse-based transmission gained momentum in military applications in the form of impulse radars. Some of the pioneers of modern UWB communications in the United States from the late 1960s are Henning Harmuth of Catholic University of America and Gerald Ross and K. W. Robins of Sperry Rand Corporation [2]. From the 1960s to the 1990s, this technology was restricted to military and Department of Defense (DoD) applications under classified programs such as highly secure communications. However, the recent advancement in microprocessing and fast switching in semiconductor technology has made UWB ready for commercial applications. Therefore, it is more appropriate to consider UWB as a new name for a long-existing technology.

As interest in the commercialization of UWB has increased over the past several years, developers of UWB systems began pressuring the FCC to approve UWB for commercial use. In February 2002, the FCC approved the First Report and Order (R&O) for commercial use of UWB technology under strict power emission limits for various devices. Sections 1.9 and 1.10 present a detailed recent history of the standardization and worldwide regulation of UWB technology. Figure 1–1 summarizes the development timeline of UWB.

CHAPTER I INTRODUCTION TO ULTRA-WIDEBAND COMMUNICATIONS

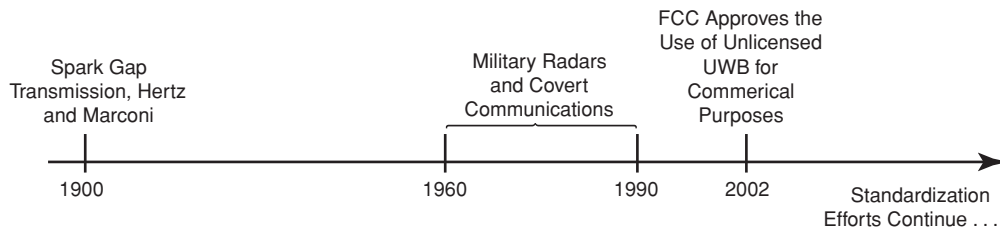

Figure I-1 A brief history of UWB developments

1.3 UWB CONCEPTS

Traditional narrowband communications systems modulate continuous-waveform (CW) RF signals with a specific carrier frequency to transmit and receive information. A continuous waveform has a well-defined signal energy in a narrow frequency band that makes it very vulnerable to detection and interception. Figure 1-2 represents a narrowband signal in the time and frequency domains.

As mentioned in Section 1.2, UWB systems use carrierless, short-duration (picosecond to nanosecond) pulses with a very low duty cycle (less

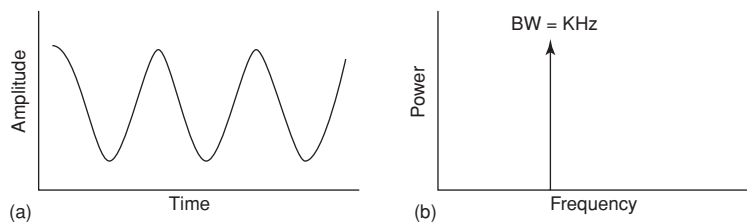

Figure I-2 A narrowband signal in (a) the time domain and (b) the frequency domain

1.3 UWB CONCEPTS

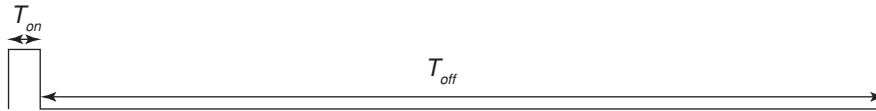

Figure 1–3 A low-duty-cycle pulse. T_{on} represents the time that the pulse exists and T_{off} represents the time that the pulse is absent.

than 0.5 percent) for transmission and reception of the information. A simple definition for *duty cycle* is the ratio of the time that a pulse is present to the total transmission time. Figure 1–3 and Equation 1–1 represent the definition of duty cycle.

$$Duty\ Cycle = \frac{T_{on}}{T_{on} + T_{off}} \quad (1-1)$$

Low duty cycle offers a very low average transmission power in UWB communications systems. The average transmission power of a UWB system is on the order of microwatts, which is a thousand times less than the transmission power of a cell phone! However, the peak or instantaneous power of individual UWB pulses can be relatively large,² but because they are transmitted for only a very short time ($T_{on} < 1$ nanosecond), the average power becomes considerably lower. Consequently, UWB devices require low transmit power due to this control over the duty cycle, which directly translates to longer battery life for handheld equipment. Since frequency is inversely related to time, the short-duration UWB pulses

2. The peak power of UWB pulses in some cases is reported to be about 1 watt for 1 Mbps at 1 MHz [3].

CHAPTER 1 INTRODUCTION TO ULTRA-WIDEBAND COMMUNICATIONS

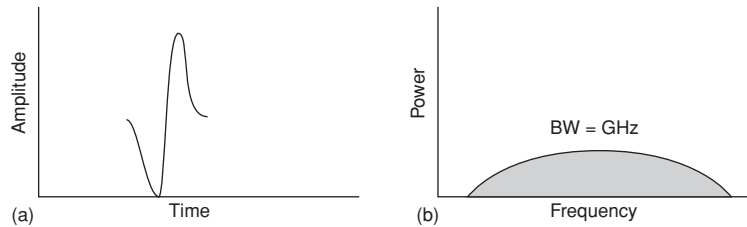

Figure 1-4 A UWB pulse in (a) the time domain and (b) the frequency domain. Compare the bandwidth and power spectral density with those of the narrowband signal in Figure 1-2.

spread their energy across a wide range of frequencies—from near DC to several gigahertz (GHz)—with very low power spectral density (PSD).³ Figure 1-4 illustrates UWB pulses in time and frequency domains.

The wide instantaneous bandwidth results from the time-scaling property of theoretical Fourier transforms:

$$x(at) \longleftrightarrow \frac{1}{|a|} X\left(\frac{f}{a}\right) \quad (1-2)$$

The notation on the left side of Equation 1-2 shows a signal, $x(t)$, which is scaled in the time domain by a factor a ; the right side represents the same signal in the frequency domain, $X(f)$, which is inversely scaled by the same factor a . For example, a pulse with duration T of 500 picoseconds can generate a center frequency f_c of 2 GHz:

$$f_c = \frac{1}{T} = \frac{1}{500 \times 10^{-12}} = 2 \times 10^9 \text{ Hz} = 2 \text{ GHz} \quad (1-3)$$

3. Power spectral density is the signals' power in the frequency domain.

I.4 UWB SIGNALS

As defined by the FCC's First Report and Order, UWB signals must have bandwidths of greater than 500 MHz or a fractional bandwidth larger than 20 percent at all times of transmission [3]. Fractional bandwidth is a factor used to classify signals as narrowband, wideband, or ultra-wideband and is defined by the ratio of bandwidth at -10 dB points⁴ to center frequency. Equation 1-4 shows this relationship.

$$B_f = \frac{BW}{f_c} \times 100\% = \frac{(f_h - f_l)}{(f_h + f_l)/2} \times 100\% = \frac{2(f_h - f_l)}{f_h + f_l} \times 100\% \quad (1-4)$$

where f_h and f_l are the highest and lowest cutoff frequencies (at the -10 dB point) of a UWB pulse spectrum, respectively. A UWB signal can be any one of a variety of wideband signals, such as Gaussian, chirp, wavelet, or Hermite-based short-duration pulses. Figure 1-5 represents a Gaussian monocycle as an example of a UWB pulse in the time and frequency domains. The Gaussian monocycle is the first derivative of a Gaussian pulse and is given by

$$P(t) = \frac{t}{\tau} e^{-\left(\frac{t}{\tau}\right)^2} \quad (1-5)$$

where t represents time and τ is a time decay constant that determines the temporal width of the pulse.

As shown in Figure 1-5, a 500-picosecond pulse generates a large bandwidth in the frequency domain with a center frequency of 2 GHz. In Fig-

4. The -10 dB point represents the spectral power of a signal at 10 dB lower than its peak power.

CHAPTER 1 INTRODUCTION TO ULTRA-WIDEBAND COMMUNICATIONS

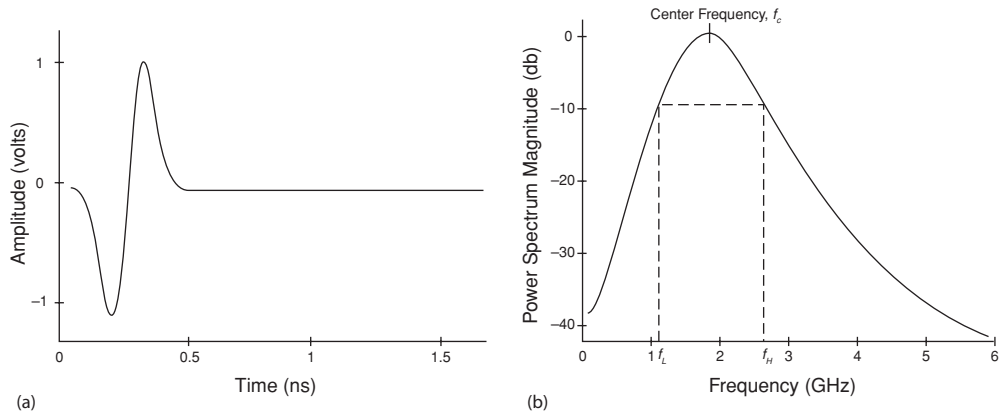

Figure 1-5 A 500-picosecond Gaussian monocycle in (a) the time domain and (b) the frequency domain

ure 1-5b, the lowest and highest cutoff frequencies at -10 dB are approximately 1.2 GHz and 2.8 GHz, respectively, which lead to a fractional bandwidth of 80 percent; this is much larger than the minimum B_f required by the FCC:

$$B_f = 2 \times \frac{(2.8 - 1.2)}{2.8 + 1.2} \times 100\% = 80\%.$$

Here is the classification of signals based on their fractional bandwidth:

Narrowband	$B_f < 1\%$
Wideband	$1\% < B_f < 20\%$
Ultra-Wideband	$B_f > 20\%$

For example, 802.11 and Bluetooth have fractional bandwidths of 0.8 percent and 0.04 percent, respectively.

I.5 ADVANTAGES

The nature of the short-duration pulses used in UWB technology offers several advantages over narrowband communications systems. In this section, we discuss some of the key benefits that UWB brings to wireless communications.

I.5.1 ABILITY TO SHARE THE FREQUENCY SPECTRUM

The FCC's power requirement of -41.3 dBm/MHz,⁵ equal to 75 nano-watts/MHz for UWB systems, puts them in the category of unintentional radiators, such as TVs and computer monitors. Such power restriction allows UWB systems to reside below the noise floor of a typical narrowband receiver and enables UWB signals to coexist with current radio services with minimal or no interference. However, this all depends on the type of modulation used for data transfer in a UWB system.

As we discuss in Chapter 3, some modulation schemes generate undesirable discrete spectral lines in their PSD, which can both increase the chance of interference to other systems and increase the vulnerability of the UWB system to interference from other radio services. In Chapter 4, we present a detailed discussion on interference from UWB on narrowband and wideband radio systems. Figure 1–6 illustrates the general idea of UWB's coexistence with narrowband and wideband technologies.

5. The abbreviation *dBm* stands for decibels per milliwatt. Hence, -41.3 dBm/MHz is equal to 75 nW/MHz.

CHAPTER 1 INTRODUCTION TO ULTRA-WIDEBAND COMMUNICATIONS

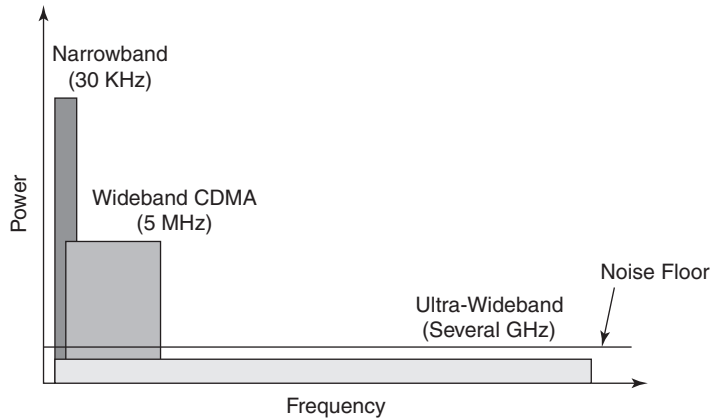

Figure 1-6 Coexistence of UWB signals with narrowband and wideband signals in the RF spectrum

1.5.2 LARGE CHANNEL CAPACITY

One of the major advantages of the large bandwidth for UWB pulses is improved channel capacity. *Channel capacity*, or data rate, is defined as the maximum amount of data that can be transmitted per second over a communications channel. The large channel capacity of UWB communications systems is evident from Hartley-Shannon's capacity formula:

$$C = B \log_2(1 + SNR) \quad (1-5)$$

where C represents the maximum channel capacity, B is the bandwidth, and SNR is the signal-to-noise power ratio. As shown in Equation 1-5, channel capacity C linearly increases with bandwidth B . Therefore, having several gigahertz of bandwidth available for UWB signals, a data rate of gigabits per second (Gbps) can be expected. However, due to the FCC's

I.5 ADVANTAGES

current power limitation on UWB transmissions, such a high data rate is available only for short ranges, up to 10 meters. This makes UWB systems perfect candidates for short-range, high-data-rate wireless applications such as wireless personal area networks (WPANs). The trade-off between the range and the data rate makes UWB technology ideal for a wide array of applications in military, civil, and commercial sectors. We explore such applications later in this chapter and in Chapter 5.

I.5.3 ABILITY TO WORK WITH LOW SIGNAL-TO-NOISE RATIOS

The Hartley-Shannon formula for maximum capacity (Equation 1–5) also indicates that the channel capacity is only logarithmically dependent on signal-to-noise ratio (SNR). Therefore, UWB communications systems are capable of working in harsh communication channels with low SNRs and still offer a large channel capacity as a result of their large bandwidth.

I.5.4 LOW PROBABILITY OF INTERCEPT AND DETECTION

Because of their low average transmission power, as discussed in previous sections, UWB communications systems have an inherent immunity to detection and intercept. With such low transmission power, the eavesdropper has to be very close to the transmitter (about 1 meter) to be able to detect the transmitted information. In addition, UWB pulses are time modulated with codes unique to each transmitter/receiver pair. The time modulation of extremely narrow pulses adds more security to UWB transmission, because detecting picosecond pulses without knowing when they will arrive is next to impossible. Therefore, UWB systems hold significant promise of achieving highly secure, low probability of intercept and detection (LPI/D) communications that is a critical need for military operations.

CHAPTER 1 INTRODUCTION TO ULTRA-WIDEBAND COMMUNICATIONS

1.5.5 RESISTANCE TO JAMMING

Unlike the well-defined narrowband frequency spectrum, the UWB spectrum covers a vast range of frequencies from near DC to several gigahertz and offers high processing gain for UWB signals. Processing gain (PG) is a measure of a radio system's resistance to jamming and is defined as the ratio of the RF bandwidth to the information bandwidth of a signal:

$$PG = \frac{RF \text{ Bandwidth}}{Information \text{ Bandwidth}} \quad (1-6)$$

The frequency diversity caused by high processing gain makes UWB signals relatively resistant to intentional and unintentional jamming, because no jammer can jam every frequency in the UWB spectrum at once. Therefore, if some of the frequencies are jammed, there is still a large range of frequencies that remains untouched. However, this resistance to jamming is only in comparison to narrowband and wideband systems. Hence, the performance of a UWB communications system can still be degraded, depending on its modulation scheme, by strong narrowband interference from traditional radio transmitters coexisting in the UWB receiver's frequency band [2, 4, 5].

1.5.6 HIGH PERFORMANCE IN MULTIPATH CHANNELS

The phenomenon known as multipath is unavoidable in wireless communications channels. It is caused by multiple reflections of the transmitted signal from various surfaces such as buildings, trees, and people. The straight line between a transmitter and a receiver is the line of sight (LOS); the reflected signals from surfaces are non-line of sight (NLOS). Figure 1-7 represents the multipath phenomenon in narrowband and UWB signals.

I.5 ADVANTAGES

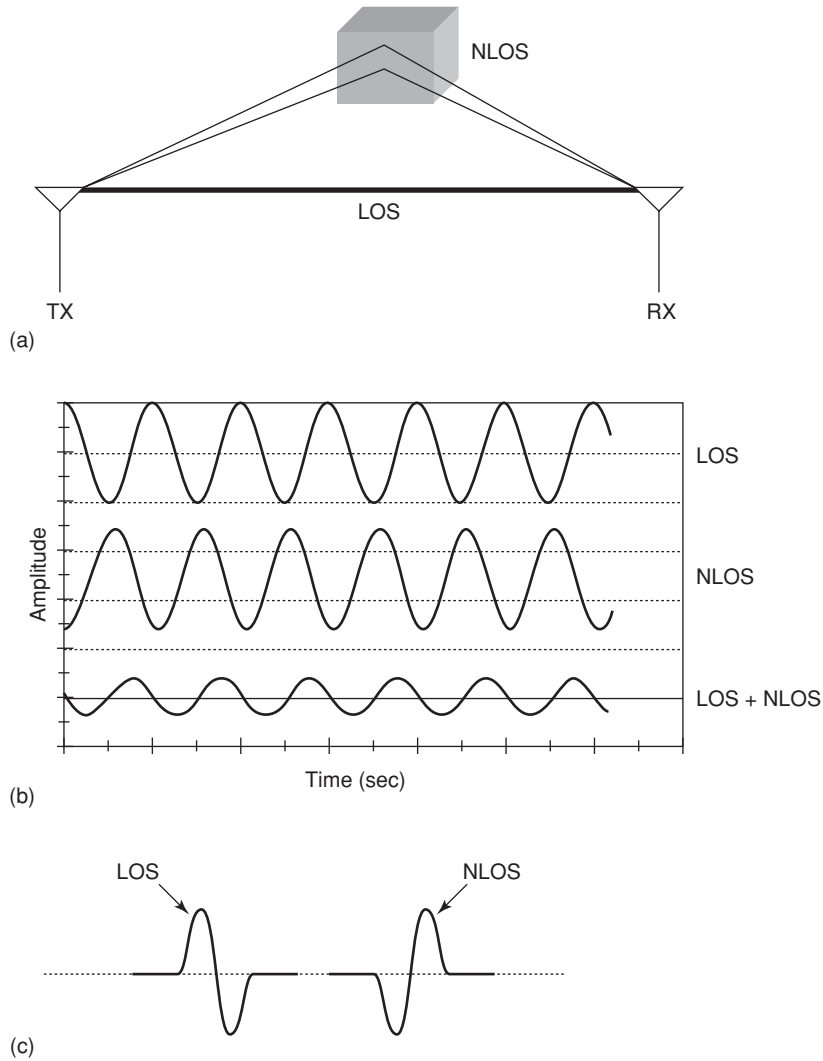

Figure I-7 (a) The multipath phenomenon in wireless links. (b) Multipath's effects on narrowband signals. (c) Multipath's effects on ultra-wideband pulses.

CHAPTER 1 INTRODUCTION TO ULTRA-WIDEBAND COMMUNICATIONS

As shown in Figure 1–7, the effect of multipath is rather severe for narrowband signals; it can cause signal degradation up to -40 dB due to the out-of-phase addition of LOS and NLOS continuous waveforms. On the other hand, the very short duration of UWB pulses makes them less sensitive to the multipath effect. Because the transmission duration of a UWB pulse is shorter than a nanosecond in most cases, the reflected pulse has an extremely short window of opportunity to collide with the LOS pulse and cause signal degradation.

Although the short duration of UWB pulses makes them less sensitive to multipath effects compared to narrowband signals, it doesn't mean that UWB communications is totally immune to multipath distortion. Research on UWB channel modeling has shown that depending on the UWB modulation scheme used, low-powered UWB pulses can become significantly distorted in indoor channels where a large number of objects and scatterers are closely spaced.

For a comprehensive discussion on various UWB modulation techniques and their performance in multipath channels, refer to Chapter 3.

1.5.7 SUPERIOR PENETRATION PROPERTIES

Unlike narrowband technology, UWB systems can penetrate effectively through different materials. The low frequencies included in the broad range of the UWB frequency spectrum have long wavelengths, which allows UWB signals to penetrate a variety of materials, including walls. This property makes UWB technology viable for through-the-wall communications and ground-penetrating radars. However, the material penetration capability of UWB signals is useful only when they are allowed to occupy the low-frequency portion of the radio spectrum.

I.5.8 SIMPLE TRANSCEIVER ARCHITECTURE

As mentioned earlier in this chapter, UWB transmission is carrierless, meaning that data is not modulated on a continuous waveform with a specific carrier frequency, as in narrowband and wideband technologies. Carrierless transmission requires fewer RF components than carrier-based transmission. For this reason UWB transceiver architecture is significantly simpler and thus cheaper to build. Figure 1–8 compares the block diagrams of typical narrowband and UWB transceivers.

As shown in Figure 1–8, the UWB transceiver architecture is considerably less complicated than that of the narrowband transceiver. The transmission of low-powered pulses eliminates the need for a power amplifier

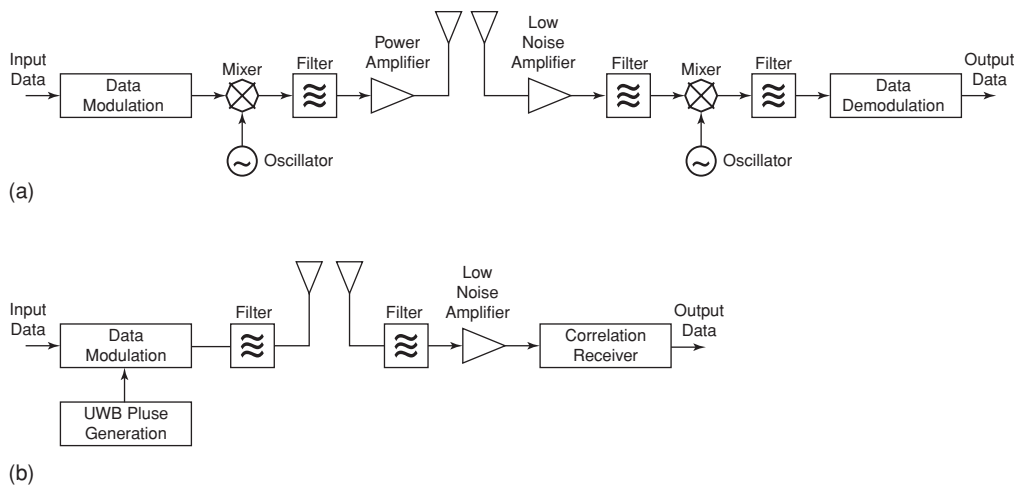

Figure 1–8 (a) A typical narrowband transceiver architecture. (b) An example of a UWB transceiver architecture.

CHAPTER 1 INTRODUCTION TO ULTRA-WIDEBAND COMMUNICATIONS

(PA) in UWB transmitters. Also, because UWB transmission is carrier-less, there is no need for mixers and local oscillators to translate the carrier frequency to the required frequency band; consequently there is no need for a carrier recovery stage at the receiver end. In general, the analog front end of a UWB transceiver is noticeably less complicated than that of a narrowband transceiver. This simplicity makes an all-CMOS (short for complementary metal-oxide semiconductors) implementation of UWB transceivers possible, which translates to smaller form factors and lower production costs.

Table 1–1 shows the main advantages and benefits of UWB systems over narrowband wireless technologies.

Table 1–1 Advantages and benefits of UWB communications

Advantage	Benefit
Coexistence with current narrowband and wideband radio services	Avoids expensive licensing fees.
Large channel capacity	High bandwidth can support real-time high-definition video streaming.
Ability to work with low SNRs	Offers high performance in noisy environments.
Low transmit power	Provides high degree of security with low probability of detection and intercept.
Resistance to jamming	Reliable in hostile environments.
High performance in multipath channels	Delivers higher signal strengths in adverse conditions.
Simple transceiver architecture	Enables ultra-low power, smaller form factor, and better mean time between failures, all at a reduced cost.

I.6 CHALLENGES

UWB technology for communications is not all about advantages. In fact, there are many challenges involved in using nanosecond-duration pulses for communications. Some of the main difficulties of UWB communications are discussed in the following subsections.

I.6.1 PULSE-SHAPE DISTORTION

The transmission characteristics of UWB pulses are more complicated than those of continuous narrowband sinusoids. A narrowband signal remains sinusoidal throughout the transmission channel. However, the weak and low-powered UWB pulses can be distorted significantly by the transmission link. We can show this distortion mathematically with the widely used Friis transmission formula:

$$P_r = P_t G_t G_r \left(\frac{c}{4\pi df}\right)^2 \quad (1-7)$$

where P_r and P_t are the received and transmitted signal power, respectively; G_t and G_r are the transmitter and receiver antenna gains, respectively; c is the speed of light;⁶ d is the distance between the transmitter and the receiver; and f is the signal frequency.

This formula shows that the received signal power will decrease quadratically with the increase in frequency. In narrowband signals with a very narrow frequency band, the change in frequency only minimally changes the received power and hence can be overlooked. However, due to the wide range of frequencies that is covered by the UWB spectrum, the

6. In a vacuum, all electromagnetic waveforms travel at the speed of light, $c = 3 \times 10^8$ meters per second.

CHAPTER 1 INTRODUCTION TO ULTRA-WIDEBAND COMMUNICATIONS

received power drastically changes and thus distorts the pulse shape. This will limit the performance of UWB receivers that correlate the received pulses with a predefined template such as classical matched filters. We discuss UWB receivers and their performance in detail in Chapter 3.

1.6.2 CHANNEL ESTIMATION

Channel estimation is a core issue for receiver design in wireless communications systems. Because it is not possible to measure every wireless channel in the field, it is important to use training sequences to estimate channel parameters, such as attenuations and delays of the propagation path. Given that most UWB receivers correlate the received signal with a predefined template signal, prior knowledge of the wireless channel parameters is necessary to predict the shape of the template signal that matches the received signal. However, as a result of the wide bandwidth and reduced signal energy, UWB pulses undergo severe pulse distortion; thus, channel estimation in UWB communications systems becomes very complicated [6].

1.6.3 HIGH-FREQUENCY SYNCHRONIZATION

Time synchronization is a major challenge and a rich area of study in UWB communications systems. As with any other wireless communications system, time synchronization between the receiver and the transmitter is a must for UWB transmitter/receiver pairs. However, sampling and synchronizing nanosecond pulses place a major limitation on the design of UWB systems. In order to sample these narrow pulses, very fast (on the order of gigahertz) analog-to-digital converters (ADCs) are needed. Moreover, the strict power limitations and short pulse duration make the performance of UWB systems highly sensitive to timing errors such as jitter and drift. This can become a major issue in the success of pulse-position

modulation (PPM) receivers, which rely on detecting the exact position of the received signal. For a thorough discussion on UWB PPM receivers, refer to Chapter 3.

1.6.4 MULTIPLE-ACCESS INTERFERENCE

In a multiuser or a multiple-access communications system, different users or devices send information independently and concurrently over a shared transmission medium (such as the air interface in wireless communications). At the receiving end, one or more receivers should be able to separate users and detect information from the user of interest. Interference from other users with the user of interest is called multiple-access interference (MAI), which is a limiting factor to channel capacity and the performance of such receivers. The addition of MAI to the unavoidable channel noise and narrowband interference discussed earlier can significantly degrade the low-powered UWB pulses and make the detection process very difficult. Figure 1–9 represents a UWB multiple-access channel.

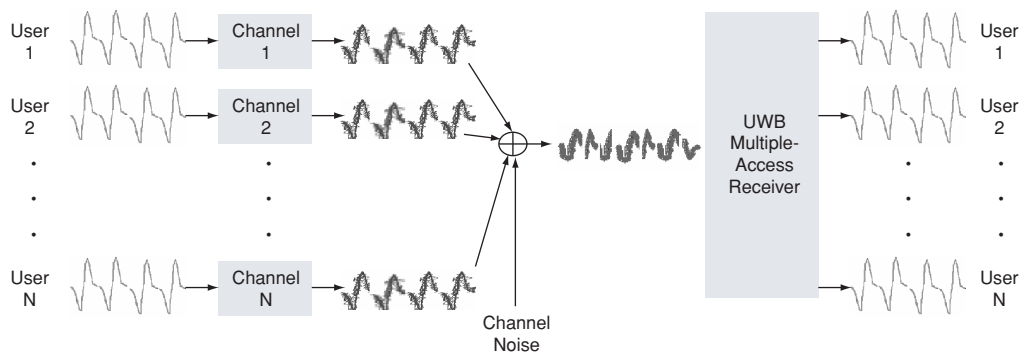

Figure 1–9 A UWB multiple-access channel

CHAPTER 1 INTRODUCTION TO ULTRA-WIDEBAND COMMUNICATIONS

Table 1–2 Some challenges and problems associated with UWB systems

Challenge	Problem
Pulse-shape distortion	Low performance using classical matched filter receivers.
Channel estimation	Difficulty predicting the template signals.
High-frequency synchronization	Very fast ADCs required.
Multiple-access interference	Detecting the desired user's information is more challenging than in narrowband communication.
Low transmission power	Information can travel only short distances.

As shown in Figure 1–9, separating each user's information from the combination of heavily distorted and low-powered UWB signals from all users is a very challenging task. A comprehensive study of multiple-access techniques in UWB systems appears in Chapter 3.

Table 1–2 summarizes the challenges and problems that narrow pulses can bring to UWB communications systems.

1.7 DIFFERENCES BETWEEN UWB AND SPREAD SPECTRUM

Although UWB is a growing technology and more information on its concepts and capabilities becomes available every day, many misconceptions are associated with its name. A good number of people confuse UWB communications with wideband spread-spectrum techniques. Even though both UWB and spread-spectrum techniques have their origins in military secure communications, we need to clarify a fundamental difference between the two. For this reason, it is important to briefly review two commonly used spread-spectrum techniques—DSSS and FHSS.

I.7 DIFFERENCES BETWEEN UWB AND SPREAD SPECTRUM

I.7.1 DIRECT-SEQUENCE SPREAD SPECTRUM

In direct-sequence spread spectrum (DSSS), a pseudorandom code is used to spread each data bit with a large number of chips, where a chip interval is much smaller than a bit interval, as shown in Figure 1–10. These code words spread the data to a larger bandwidth than required to transmit information. In Figure 1–10, the data bit 1 is represented by a four-bit code (1010) and the data bit 0 is represented by another four-bit code (1100).

Spreading the data to shorter duration chips in time results in a spread of energy in the frequency domain to slightly above a typical narrowband receiver's noise floor. In order to transmit data, each of the chips is modulated with conventional narrowband techniques.

I.7.2 FREQUENCY-HOPPING SPREAD SPECTRUM

The frequency-hopping spread-spectrum (FHSS) technique was invented by actress Hedy Lamarr and patented in 1942 as “Secret Communication System” [7]. FHSS in concept is exactly like DSSS in terms of spreading the signal energy in the frequency domain and offering the advantages of wideband communications. However, the wide bandwidth does not

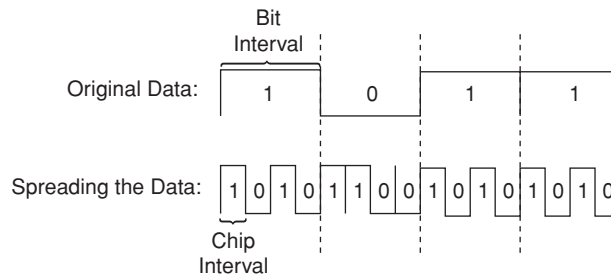

Figure 1–10 A data sequence and a spreading code using DSSS

CHAPTER I INTRODUCTION TO ULTRA-WIDEBAND COMMUNICATIONS

result from spreading the data, as in the DSSS technique. Instead, FHSS hops the frequencies used for transmission and reception according to a pseudorandom code, and the combination of those frequencies generates a wide bandwidth. The change in frequencies that represent the data bits happens so fast that detection becomes very difficult for unauthorized parties. As shown in Figure 1–11, the signal hops from one frequency to another at each instance in time.

1.7.3 THE ESSENTIAL DIFFERENCES

Both the DSSS and the FHSS techniques offer a spread in the frequency domain and provide advantages over narrowband communications such as lower power spectral density, covertness, frequency diversity for better performance in multipath channels, and resistance to intentional and unintentional jamming. So the natural question is “What is the difference between UWB and spread spectrum?”

Although UWB and spread-spectrum techniques share the same advantage of expanded bandwidth, the method of achieving the large bandwidth is the main distinction between the two technologies. In conventional

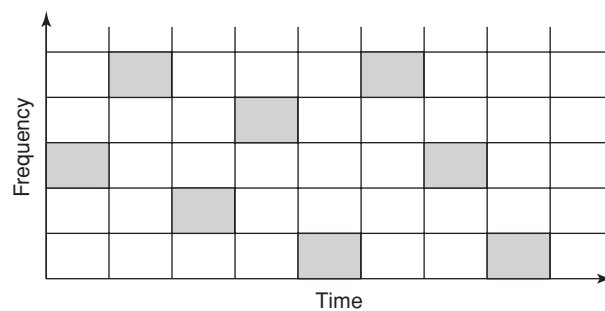

Figure 1–11 Frequency hopping in the FHSS technique

1.7 DIFFERENCES BETWEEN UWB AND SPREAD SPECTRUM

spread-spectrum techniques, the signals are continuous-wave sinusoids that are modulated with a fixed carrier frequency. In UWB communications, on the other hand, there is no carrier frequency; the short duration of UWB pulses directly generates an extremely wide bandwidth (as we saw in Equation 1–2). Another distinguishing factor in UWB is the very large bandwidth. Spread-spectrum techniques can offer megahertz of bandwidth, while UWB pulses provide several gigahertz of bandwidth. Figure 1–12 shows the time and frequency domain representation of narrowband, wideband, and UWB signals.

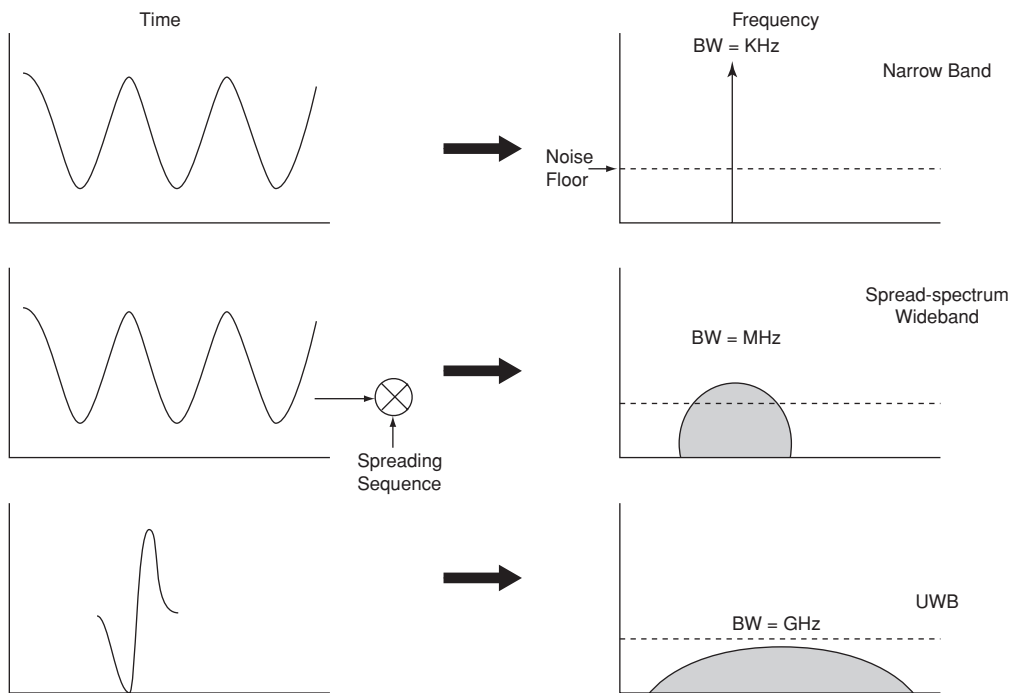

Figure 1–12 The transition from narrowband to wideband and ultra-wideband in the time and frequency domains

CHAPTER I INTRODUCTION TO ULTRA-WIDEBAND COMMUNICATIONS

As shown in Figure 1–12, in narrowband technologies, CW signals occupy a well-defined and narrow range in the frequency spectrum; however, in wideband technologies, the frequency range of the CW signals is spread to slightly above the noise floor due to the use of spreading sequences. In UWB, the short duration of a pulse automatically creates the very large bandwidth of several gigahertz without using the spreading codes. Also, notice that narrowband signals are always present, so their duty cycle is 100 percent, while UWB pulses are present only for a very short time, with a duty cycle of less than 0.5 percent. As explained in Section 1.3, the low duty cycle offers very low transmission power and extra covertness compared to spread-spectrum techniques. However, the low transmission power could be a disadvantage for UWB systems, because the information can travel only short distances. Therefore, for long-range applications, spread-spectrum techniques are still more appropriate.

I.8 SINGLE BAND VS. MULTIBAND

The ability of UWB technology to provide very high data rates for short ranges (less than 10 meters) has made it an excellent candidate for the physical layer of the IEEE 802.15.3a standard for wireless personal area networks (WPANs). However, two opposing groups of UWB developers are battling over the IEEE standard. The two competing technologies are single band and multiband. The single-band technique, backed by Motorola/XtremeSpectrum, supports the idea of impulse radio that is the original approach to UWB by using narrow pulses that occupy a large portion of the spectrum. The multiband approach divides the available UWB frequency spectrum (3.1 GHz to 10.6 GHz) into multiple smaller and nonoverlapping bands with bandwidths greater than 500 MHz to obey the FCC's definition of UWB signals. The multiband approach is supported by several companies, including Staccato Communications, Intel, Texas Instruments, General Atomics, and Time Domain Corporation.

I.8 SINGLE BAND VS. MULTIBAND

To date, several proposals from both groups have been submitted to the IEEE 802.15.3a working group, and the decision is yet to be made because both technologies are impressive and have technical credibility. The following subsections discuss the two leading candidates for the 802.15.3a standard: direct-sequence UWB (DS-UWB) and multiband orthogonal frequency division multiplexing (OFDM).

I.8.1 DIRECT-SEQUENCE UWB

Direct-sequence UWB is a single-band approach that uses narrow UWB pulses and time-domain signal processing combined with well-understood DSSS techniques to transmit and receive information. Figure 1–13 illustrates this approach.

Data representation in this approach is based on simple bi-phase shift keying (BPSK) modulation, and rake receivers are used to capture the

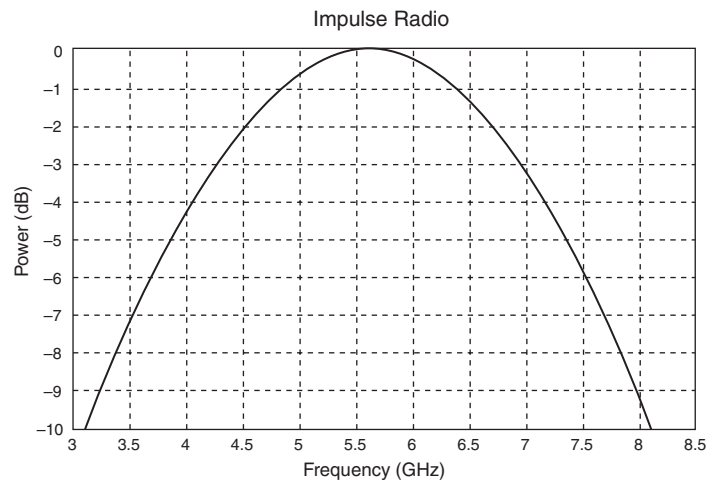

Figure 1–13 DS-UWB transmits a single pulse over a huge swath of spectrum to represent data. Courtesy of Staccato Communications Inc.

CHAPTER 1 INTRODUCTION TO ULTRA-WIDEBAND COMMUNICATIONS

signal energy from multiple paths in a multipath channel. According to the proposals sent to the IEEE 802.15.3a standardization committee by the proponents of this technology, the DS-UWB technique is scalable and can achieve data rates in excess of 1 Gbps. The technical reason behind using DS-UWB is the propagation benefits of ultra-wideband pulses, which experience no Rayleigh fading. In contrast, narrowband transmissions degrade significantly due to fading.

1.8.2 MULTIBAND OFDM

The multiband UWB approach uses the 7500 MHz of the RF spectrum available to UWB communications in a way that differs from traditional UWB techniques. The UWB frequency band is divided into multiple smaller bands with bandwidths greater than 500 MHz. Figure 1–14 depicts the result.

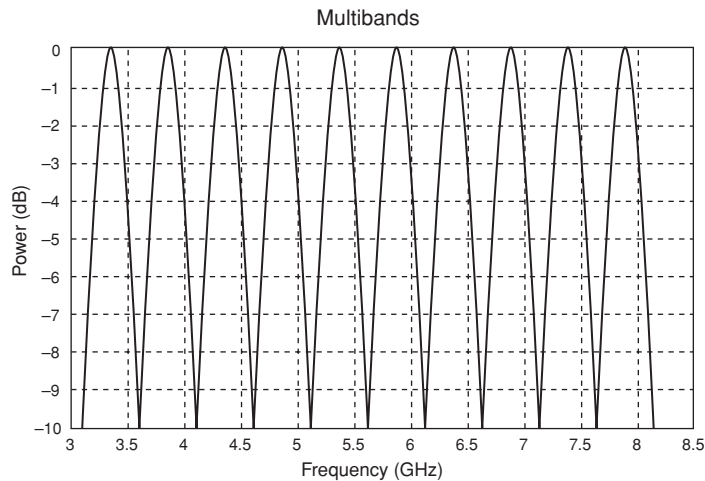

Figure 1–14 The multiband approach divides the available UWB spectrum into several nonoverlapping smaller bands. Courtesy of Staccato Communications Inc.

I.9 THE REGULATORY SITUATION

This approach is similar to the narrowband frequency-hopping technique. Dividing the UWB spectrum into multiple frequency bands offers the advantage of avoiding transmission over certain bands, such as 802.11a at 5 GHz, to prevent potential interference. In the multiband approach, UWB pulses are not as narrow as in traditional UWB techniques; therefore, synchronization requirements are more relaxed. A variety of modulation techniques have been proposed by industry leaders for the multiband approach; however, OFDM, which was initially proposed by Texas Instruments, offers improved performance for high-data-rate applications.

As explained briefly, both technologies are technically valid and impressive. Supporters of DS-UWB criticize the multiband OFDM systems for their complexity, which results from using complex Fast Fourier Transforms (FFTs). On the other side, advocates of multiband OFDM believe that their technique offers better coexistence with other radio services, and they disapprove of DS-UWB because of possible interference concerns. The debate will likely continue until the IEEE 802.15.3a standardization committee reaches a decision.

I.9 THE REGULATORY SITUATION⁷

I.9.1 CURRENT FCC REGULATIONS

On February 14, 2002, the FCC ruled to open up an unprecedented amount of bandwidth for commercial development of UWB technology. After much lobbying on both sides to either reduce or tighten the FCC restrictions, the FCC agreed to the requests of a wide range of supporters. Thus, a year later in February 2003, the FCC's release of a Memorandum Opinion and Order (MO&O) assured developers that UWB is here to stay. These supporters run the gamut from leading companies in the home

7. Section 1.9 copyright © ON World Emerging Wireless Research. Reprinted with permission.

CHAPTER 1 INTRODUCTION TO ULTRA-WIDEBAND COMMUNICATIONS

networking arena; to consumer electronics giants such as Philips Electronics and Samsung Electronics; to personal computing heavyweights such as Intel, Texas Instruments, and Microsoft; and to a growing number of UWB developers such as Multispectral Solutions, Pulse~LINK, Staccato Communications, Time Domain Corporation, and XtremeSpectrum, as well as several U.S. organizations such as the Ground Penetrating Radar Industry Coalition (GPRIC).

The FCC spectral mask (that is, the operating restrictions for UWB in the United States) specifies 7.5 GHz of usable spectrum bandwidth between 3.1 GHz and 10.6 GHz for communications devices. The FCC also protects existing users operating within this spectrum by limiting the UWB signal's transmit power. The UWB devices' power spectral density levels are limited to -41.3 dBm/MHz. The primary difference between indoor and outdoor operation is the higher degree of attenuation required for the out-of-band region for outdoor operations. This further protects GPS receivers, centered at 1.6 GHz. Previously at an IEEE meeting in July 2003, the Multiband OFDM Alliance (MBOA) and Motorola/XtremeSpectrum groups had argued over whether or not the MBOA can use a frequency-hopping technique and still meet the 802.15.3a's data and range requirements while remaining in compliance with the FCC's stated declarations on how frequency-hopping systems should be tested. While the FCC has set precedents in terms of changing the rules according to newly defined IEEE standards (for example, 802.11), few rules were as strongly debated as those for UWB. Adding to this complexity is the fact that the original UWB opponents are continuing to debate the original FCC rules [8].

In September 2003, the FCC passed on the burden to the Task Group 3a to prove that any UWB standard developed remains within the anticipated levels reflected in the current rules. This action has heated up an increasingly contentious situation between the two groups. Although UWB detractors continue to lobby, UWB is here to stay and developers are pushing on.

I.9.2 WORLDWIDE REGULATORY EFFORTS

Currently, UWB is legal only in the United States; however, international regulatory bodies are considering possible rules and emission limits that would help enable worldwide operation of UWB devices. Intel is working with local regulatory efforts in Japan, Europe, and China to achieve regulations similar to those produced by the FCC. Harmonized worldwide regulations would provide a significant benefit for UWB technology, allowing devices to be carried around the world without service interruption.

Although regulatory bodies outside the United States have been more skeptical of the viability and legality of UWB, there are many efforts under way to change this. The FCC guidelines are forming the template for global regulatory rulings, with Canada, Europe, Japan, Korea, and Singapore all interested in adhering closely to the ruling. Regulatory approval in Europe and Asia is expected soon, based on the aggressive efforts of Intel, Philips, Sony, Sharp, Panasonic, STMicroelectronics, Texas Instruments, and Motorola/XtremeSpectrum, as well as startups such as Wisair.

Europe

Europe has several UWB projects under way, such as Ultra-wideband Concepts for Ad hoc Networks (UCAN), the Ultra Wideband Audio Video Entertainment System (ULTRAWAVES), and Pervasive Ultra-wideband Low Spectral Energy Radio Systems (PULSERS).⁸ These efforts are driven by companies such as STMicroelectronics, Philips, Wisair, and XtremeSpectrum. UCAN has published reports concentrating on UWB channel propagation loss, medium access control (MAC) and routing protocols, as well as a strategy for path selection. Some UCAN partners are involved in the preparation of an FP6 (6th Framework of the EU-IST Program) Integrated

8. The goal of PULSERS is to develop novel UWB devices starting from proofs of concept to fully working prototypes.

CHAPTER I INTRODUCTION TO ULTRA-WIDEBAND COMMUNICATIONS

Project: PULSERS. Philips and Wisair are leading the PULSERS and ULTRAWAVES project. ULTRAWAVES' objective is to provide high-performance and low-cost wireless home connectivity solutions, supporting applications requiring home multistreaming of high-quality video and broadband multimedia. One of the major goals is to validate ULTRAWAVES' approach, coexistence issues, and other implementation issues in different layers. Partners include Wisair, Philips, ENSTA-Armines (a top engineering school in Paris), RadioLabs, Chalmers University of Technology, and the Centre for Wireless Communications at the University of Oulu, Finland.

Although UWB does not fit the usual regulatory paradigm, the European Community policy is to be permissive and not block or delay technologies because they don't fit in a paradigm. The European Resuscitation Council (ERC) is developing an outline for when short-range devices (including ultra-wideband systems) can be operated under special conditions.

Japan

In September 2002, after prodding from companies such as XtremeSpectrum, Texas Instruments, Intel, Sony, Sharp, and Panasonic, the Ministry of Public Management, Home Affairs, Posts and Telecommunications (MPHPT) in Japan placed an inquiry with the Telecommunications Council on "Technical Conditions for UWB Radio Systems." At the time, the Telecommunications Council was to report this one year later. However, the status on this is not yet known.

In April 2003, Intel researchers worked with regulators from the MPHPT in order to allow the first public UWB transmission in Japan, which took place at the Intel Developer Forum.

Singapore

Since February 2003, Singapore has initiated a UWB program through its Infocomm Development Authority (IDA). The aim of the two-year UWB

1.10 FCC EMISSION LIMITS

program was to encourage UWB experimentation through the introduction of trial regulations, to gather experimental data to determine regulations that will enable future commercial deployment, and to create an ecosystem of UWB players and users. The IDA will introduce regulations to permit controlled UWB emissions within a Science Park area as well as hosting a series of UWB compatibility studies. The UWB program permits experimentation with more relaxed rules than those of the FCC, in terms of emission limits and in the mode of operation. For instance, trial licensees will have the freedom to operate the devices indoors and outdoors, with no restrictions on whether the devices should be battery or AC-powered.

In April 2003, Singapore scientists at the Institute for Infocomm Research demonstrated an FCC-compliant UWB wireless link that successfully transmitted and received data at speeds exceeding 500 Mbps over a four-foot range, doubling the international record of 220 Mbps rate achieved.

1.10 FCC EMISSION LIMITS

As explained in Section 1.9, in order to protect existing radio services from UWB interference, the FCC has assigned conservative emission masks between 3.1 GHz and 10.6 GHz for commercial UWB devices. The maximum allowed power spectral density for these devices—that is, -41.3 dBm/MHz, or 75 nW/MHz—places them at the same level as unintentional radiators (FCC Part 15 class) such as televisions and computer monitors. Based on the FCC regulations, UWB devices are classified into three major categories: communications, imaging, and vehicular radar.

1.10.1 COMMUNICATIONS DEVICES

For communications devices, the FCC has assigned different emission limits for indoor and outdoor UWB devices. The spectral mask for

CHAPTER 1 INTRODUCTION TO ULTRA-WIDEBAND COMMUNICATIONS

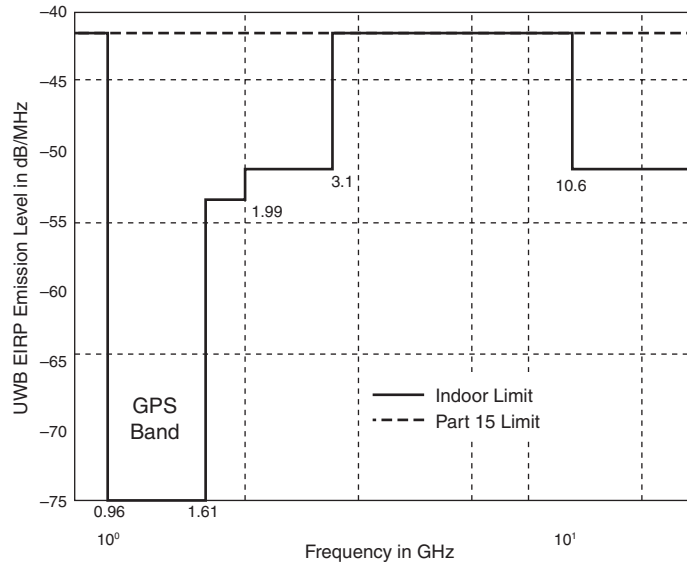

Figure 1-15 UWB emission limits for indoor communications systems. From E. Thomas, “Walk Don’t Run: The First Step in Authorizing Ultra-Wideband Technology,” *IEEE Conference on Ultra Wideband Systems and Technologies (UWBST)*, May 2002. Copyright © 2002 IEEE. Used with permission.

outdoor devices is 10 dB lower than that for indoor devices, between 1.61 GHz and 3.1 GHz, as shown in Figures 1-15 and 1-16, respectively.

According to FCC regulations, indoor UWB devices must consist of handheld equipment, and their activities should be restricted to peer-to-peer operations inside buildings.

The FCC’s rule dictates that no fixed infrastructure can be used for UWB communications in outdoor environments. Therefore, outdoor UWB communications are restricted to handheld devices that can send information only to their associated receivers.

1.10 FCC EMISSION LIMITS

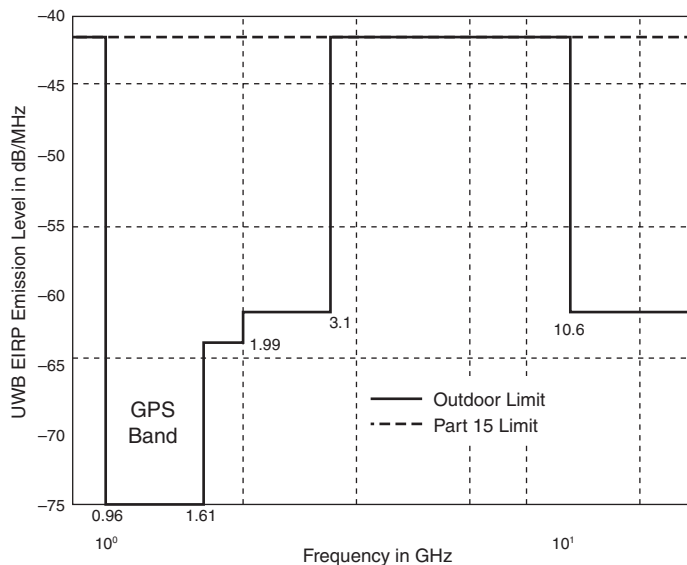

Figure 1-16 UWB emission limits for outdoor handheld devices
 From E. Thomas, "Walk Don't Run: The First Step in Authorizing Ultra-Wideband Technology," *IEEE Conference on Ultra Wideband Systems and Technologies (UWBST)*, May 2002. Copyright © 2002 IEEE. Used with permission.

1.10.2 IMAGING DEVICES

Figure 1-17 shows the FCC emission limit for UWB-based through-wall imaging devices. The operation of these devices is constrained to law enforcement and rescue teams.

CHAPTER 1 INTRODUCTION TO ULTRA-WIDEBAND COMMUNICATIONS

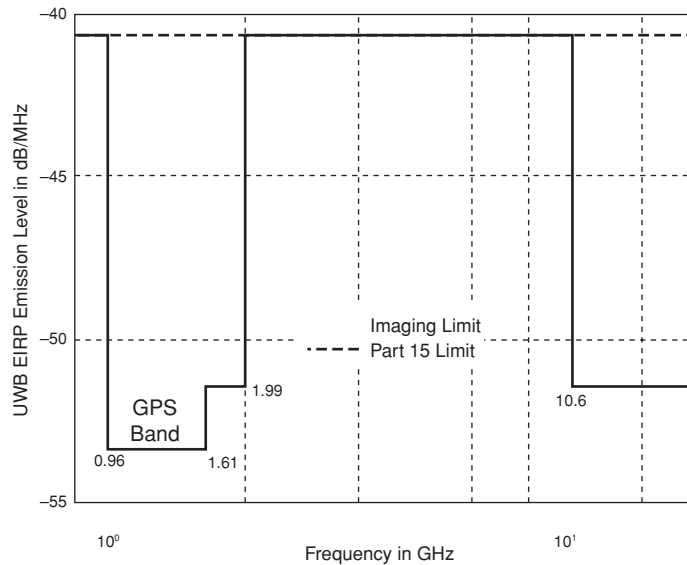

Figure 1-17 UWB emission limits for through-wall imaging systems
 From E. Thomas, “Walk Don’t Run: The First Step in Authorizing Ultra-Wideband Technology,” *IEEE Conference on Ultra Wideband Systems and Technologies (UWBST)*, May 2002. Copyright © 2002 IEEE. Used with permission.

1.10.3 VEHICULAR RADAR SYSTEMS

Vehicular radar systems are allowed to emit -41.3 dBm/MHz only in the 22 GHz to 29 GHz frequency range. The center frequency of their signal should be higher than 24.075 GHz. These radar devices are allowed to be mounted on terrestrial transportation vehicles and can be activated either while the vehicles are moving or while they are stationary. Figure 1-18 shows the FCC emission limit for UWB-based vehicular radar systems.

1.10 FCC EMISSION LIMITS

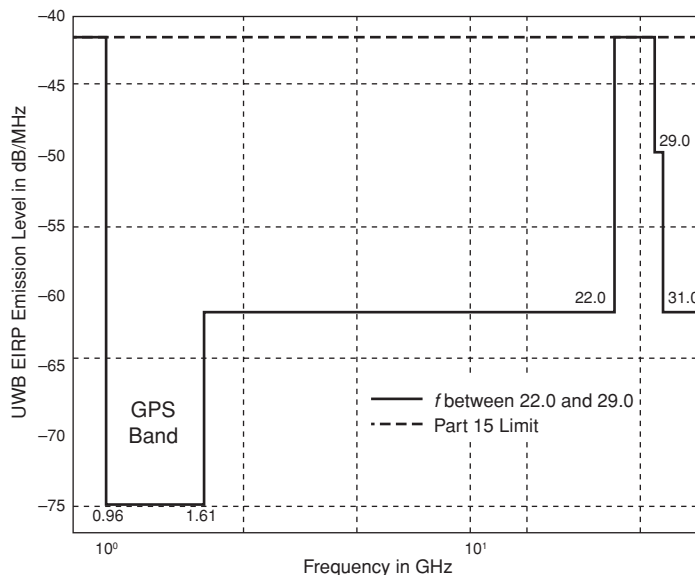

Figure 1-18 Figure 1-18. UWB emission limits for vehicular radar systems
 From E. Thomas, "Walk Don't Run: The First Step in Authorizing Ultra-Wideband Technology," *IEEE Conference on Ultra Wideband Systems and Technologies (UWBST)*, May 2002. Copyright © 2002 IEEE. Used with permission.

In general, the FCC ruling per application with Part 15 classification of -41.3 dBm for both outdoor and indoor operations can be summarized as shown in Table 1-3.

CHAPTER 1 INTRODUCTION TO ULTRA-WIDEBAND COMMUNICATIONS

Table 1-3 Emission limits for various UWB applications in each operational band

		Operation Band (GHz)						
		0.96 to 1.61	1.61 to 1.99	1.99 to 3.1	3.1 to 10.6	10.6 to 22.0	22.0 to 29.0	
ERIP (dBm)	Communications	Indoor	-75.3	-53.3	-51.3	-41.3	-51.3	-51.3
		Outdoor	-75.3	-63.3	-61.3	-41.3	-61.3	-61.3
	Imaging		-53.3	-51.3	-41.3	-41.3	-41.3	-51.3
	Vehicular Radar		-75.3	-63.3	-63.3	-63.3	-41.3	-41.3

1.11 UWB APPLICATIONS

The trade-off between data rate and range in UWB systems holds great promise for a wide variety of applications in military, civilian, and commercial sectors. Chapter 5 contains a detailed discussion of UWB's present and future applications. For now, we present a brief summary of UWB applications to complete our introductory discussion.

As explained in Sections 1.9 and 1.10, the FCC categorizes UWB applications as either radar, imaging, or communications devices. Radar is considered one of the most powerful applications of UWB technology. The fine positioning characteristics of narrow UWB pulses enables them to offer high-resolution radar (within centimeters) for military and civilian applications. Also, because of the very wide frequency spectrum band, UWB signals can easily penetrate various obstacles. This property makes UWB-based ground-penetrating radar (GPR) a useful asset for rescue and disaster recovery teams for detecting survivors buried under rubble in disaster situations.

I.11 UWB APPLICATIONS

In the commercial sector, such radar systems can be used on construction sites to locate pipes, studs, and electrical wiring. The same technology under different regulations can be used for various types of medical imaging, such as remote heart monitoring systems. In addition, UWB radar is used in the automotive industry for collision avoidance systems.

Moreover, the low transmission power of UWB pulses makes them ideal candidates for covert military communications. UWB pulses are extremely difficult to detect or intercept; therefore, unauthorized parties will not get access to secure military information. Also, because UWB devices have simpler transceiver circuitry than narrowband transceivers, they can be manufactured in small sizes at a lower price than narrowband systems.

Small and inexpensive UWB transceivers are excellent candidates for wireless sensor network applications for both military and civilian use. Such sensor networks are used to detect a physical phenomenon in an inaccessible area and transfer the information to a destination. A military application could be the detection of biological agents or enemy tracking on the battlefield. Civilian applications might include habitat monitoring, environment observation, health monitoring, and home automation.

The precise location-finding ability of UWB systems can be used in inventory control and asset management applications, such as tagging and identification systems—for example, RFID tags. Also, the good performance of UWB devices in multipath channels can provide accurate geolocation capability for indoor and obscured environments where GPS receivers won't work.

The high-data-rate capability of UWB systems for short distances has numerous applications for home networking and multimedia-rich

CHAPTER 1 INTRODUCTION TO ULTRA-WIDEBAND COMMUNICATIONS

Table 1–4 UWB capabilities compared to other IEEE standards

	IEEE Standard						
	WLAN		Bluetooth	WPAN	UWB	ZigBee	
	802.11a	802.11b	802.11g	802.15.1	802.15.3	802.15.3a	802.15.4
Operational Frequency	5 GHz	2.4 GHz	2.4 GHz	2.4 GHz	2.4 GHz	3.1–10.6 GHz	2.4 GHz
Maximum Data Rate	54 Mbps	11 Mbps	54 Mbps	1 Mbps	55 Mbps	> 100 Mbps	250 Kbps
Maximum Range	100 meters	100 meters	100 meters	10 meters	10 meters	10 meters	50 meters

communications in the form of WPAN applications. UWB systems could replace cables connecting camcorders and VCRs, as well as other consumer electronics applications, such as laptops, DVDs, digital cameras, and portable HDTV monitors. No other available wireless technologies—such as Bluetooth or 802.11a/b—are capable of transferring streaming video. Table 1–4 compares UWB technology and other currently available data communications standards.

Table 1–5 summarizes UWB applications in data communications, radar, and localization.

Table I-5 Some UWB applications in military and commercial sectors

	Applications	
	Military and Government	Commercial
Data Communications	Secure LPI/D communications Covert wireless sensor networks (battlefield operations)	Local and personal area networks Wireless streaming video distribution (home networking) Wireless sensor networks (health and habitat monitoring, home automation)
Radar	Through-wall imaging (for law enforcement, firefighters) Ground-penetrating radar (for rescue operations) Surveillance and monitoring	Medical imaging (remote heart monitoring) Ground-penetrating radar (detection of electrical wiring, studs, etc. on construction sites) Automotive industry (collision avoidance, roadside assistance) Home security (proximity detectors)
Localization	Personnel identification Lost children Prisoner tracking	Inventory tracking Tagging and identification Asset management

I.12 SUMMARY

With the recent advances in semiconductor device technology and the FCC's approval of the unlicensed use of ultra-wideband systems, UWB development has moved from research labs and classified military

CHAPTER I INTRODUCTION TO ULTRA-WIDEBAND COMMUNICATIONS

projects to the commercial sector. UWB technology brings many opportunities as well as challenges to the world of wireless communications.

In this introductory chapter, we reviewed the history, background, and basic concepts of UWB communications. We identified the major advantages and challenges of this emerging technology and reviewed the fundamental differences between narrowband, wideband, and ultra-wideband communications. Also, we introduced the two UWB leading candidates for the IEEE 802.15.3a WPAN standard: single-band and multiband UWB approaches. We also discussed the current worldwide regulatory situation regarding UWB, as well as the FCC emission limits on UWB devices in the United States. Finally, we briefly explained the applications of UWB for military, government, and commercial uses. A comprehensive discussion of UWB applications and target markets is available in Chapter 5.

REFERENCES

1. Online article, <http://archives.cnn.com/2000/TECH/computing/05/08/itu.spectrum.idg/>, May 8, 2000.
2. R. Fontana, "A Brief History of UWB Communications," online article, <http://www.multispectral.com/history.html>
3. Online article, <http://www.fcc.gov/oet/info/rules>
4. T. W. Barrett, "History of UltraWideBand (UWB) Radar & Communications: Pioneers and Innovators," in *Proceedings of Progress in Electromagnetics Symposium 2000*, Cambridge, Mass., July 2000.
5. C. L. Bennett and G. F. Ross, "Time-Domain Electromagnetics and Its Applications," in *Proceedings of the IEEE 66*, 1978, pp. 229–318.
6. I. J. Lahaie, ed., *Ultrawideband Radar: SPIE Proceedings*, vol. 1631, January 1992.

7. Online article, <http://www.qsl.net/n9zia/fhss/02292387.pdf>
8. G. F. Ross, "Early Developments and Motivations for Time-Domain Analysis and Application," in *Time-Domain Measurements in Electromagnetics 1*, E. K. Miller, ed., pp. 1–44. New York: Van Nostrand Reinhold, 1986.

BIBLIOGRAPHY

2002 IEEE Conference on Ultra-Wideband Systems and Technologies, Baltimore, Md., May 2002.

- L. Y. Astanin and A. A. Kostylev, "Ultra Wideband Signals—A New Step in Radar Development," *IEEE AES Systems Magazine*, March 1992, pp. 12–15.
- H. L. Bertoni, L. Carin, and L. B. Felsen, eds., *Ultra-Wideband Short-Pulse Electromagnetics*. New York: Plenum Press, 1993.
- J. R. Davis, D. J. Baker, J. P. Shelton, and W. S. Ament, "Some Physical Constraints on the Use of 'Carrier-Free' Waveforms in Radio-Wave Transmission Systems," in *Proceedings of the IEEE*, vol. 67, no. 6, June 1979, pp. 884–891.
- H. F. Engler, Jr., "Technical Issues in Ultra-Wideband Radar Systems," in *Introduction to Ultra-Wideband Radar Systems*, J. D. Taylor, ed. Boston: CRC Press, 1994.
- R. Fleming and C. Kushner, "Low-Power, Miniature, Distributed Position Location and Communication Devices Using Ultra-Wideband, Non-sinusoidal Communication Technology," Aether Wire & Location, Inc., report to ARPA/FBI, online at http://www.aetherwire.com/PI_Report_95/awl_pi95.pdf, July 1995.
- J. Foerster, E. Green, S. Somayazulu, and D. Leeper, "Ultra-Wideband Technology for Short- or Medium-Range Wireless Communications," *Intel Technology Journal*, Q2, 2001.
-

CHAPTER I INTRODUCTION TO ULTRA-WIDEBAND COMMUNICATIONS

- R. J. Fontana and S. J. Gunderson, "Ultra-Wideband Precision Asset Location System," in *2002 IEEE Conference on Ultra Wideband Systems and Technologies*, Baltimore, Md., May 2002.
- R. Fontana et al., "Recent Advances in Ultra-Wideband Communications Systems," in *2002 IEEE Conference on Ultra Wideband Systems and Technologies*, Baltimore, Md., May 2002.
- G. V. Glebovich, A. V. Andriyanov, V. Vvedenskij, I. P. Kovalev, V. V. Krylov, and A. Ryabinin, "Study of Objects Using Picosecond Pulses," Moscow: Radio I Svyaz, 1984.
- H. F. Harmuth, "Frequency-Sharing and Spread-Spectrum Transmission with Large Relative Bandwidth," *IEEE Transactions on Electromagnetics Compatibility*, vol. EMC-20, no. 1, February 1978, pp. 232–239.
- E. Heyman, J. Shiloh, and B. Mandelbaum, eds., *Ultra-Wideband Short-Pulse Electromagnetics 4*, New York: Plenum Press, 1999.
- M. G. M. Hussain, "An Overview of the Developments in Nonsinusoidal Wave Technology," in *Proceedings of the 1985 IEEE National Radar Conference*, 1985, pp. 190–196.
- W. Kissick, "Ultra-wideband (UWB) Applications," online article, Institute for Telecommunications Sciences, http://www.its.blrdoc.gov/home/programs/uwb/uwb_app.html
- S. S. Kolenchery, J. K. Townsend, and J. A. Freebersyser, "A Novel Impulse Radio Network for Tactical Military Communications," in *Proceedings of IEEE Military Communications Conference*, pp. 59–65, 1998.
- V. Krymscy, V. Bucharin, and V. Zaliapin, *Theory of Nonsinusoidal Waves*, Russian Federation: Cheliabinsk State Technical University Press, 1995.
- J. McCorkle, "A Tutorial on Ultrawideband Technology," Doc. IEEE 802.15-00/082r0, March 2000.

- A. M. Nicholson, "Advances in Subnanosecond Pulse Technology," Physics and Electronics Department, Royal Radar Establishment Seminar, Malvern, England, January 1972.
- B. Noel, ed., *Ultra-Wideband Radar: Proceedings of the First Los Alamos Symposium*. Boston: CRC Press, 1991.
- Roke Manor Research, "Ultra-Wideband Communications," online article, <http://www.roke.co.uk/uwb/comms.asp>
- G. F. Ross, "A Time-Domain Criterion for the Design of Wideband Radiating Elements," *IEEE Transactions on Antennas and Propagation*, vol. 16, no. 3, 1968.
- R. A. Scholtz et al., "UWB Radio Deployment Challenges," in *Proceedings of the PIMRC 2000*, online at http://ultra.usc.edu/New_Site/publications.html
- J. D. Taylor, ed. *Introduction to Ultra-Wideband Radar Systems*. Boca Raton, Fla.: CRC Press, 1995.
- P. Van Etten, "The Present Technology of Impulse Radars," in *International Radar Conference Proceedings*, pp. 535–539, October 1977.
- A. J. Viterbi, "Spread Spectrum Communications—Myths and Realities," *IEEE Communications Magazine*, May 1979, pp. 11–18.
- M. Welborn and K. Siwiak, eds., "Ultra-Wideband Tutorial," IEEE 802.15 document, online at http://grouper.ieee.org/groups/802/15/pub/2002/Mar02/02133r1P802-15_WG-Ultra-Wideband-Tutorial.ppt, March 2002.
- J. Wilson, "Ultra-Wideband: A Disruptive RF Technology?" Intel Research and Development, online at http://developer.intel.com/technology/ultrawideband/downloads/Ultra-Wideband_Technology.pdf, 10 September 2002.
- M. Z. Win and R. A. Scholtz, "Impulse Radio: How It Works," *IEEE Communications Letters*, vol. 2, no. 2, January 1998, pp. 36–38.

CHAPTER I INTRODUCTION TO ULTRA-WIDEBAND COMMUNICATIONS

P. Withington, "Ultra-wideband RF: A Tutorial," Doc. IEEE 802.15-00/083r0, online at http://grouper.ieee.org/groups/802/15/pub/2000/Mar00/00083r0P802-15_WG-UWB-Tutorial-1-Time-Domain.PDF, March 2000.